



BULL20M / BULL20T

AUTOMATIONS FOR SLIDING GATES INDUSTRIAL USE

personalised release key
 BULL20M: control with built-in encoder and receiver
 BULL20T: no control unit
up to 2,000 kg



CONTROL PANELS:

BULL20M	CP.BULL-RI	p.129
BULL20M.S	CP.BULL-RI	p.129
BULL20T	THINK START	p.119 p.120
BULL20T.S	THINK START	p.119 p.120

DESCRIPTION

Irreversible electromechanical geared motor available in 230 Vac single phase or 400 Vac three phase version, self ventilated. Full metal release system.

230 Vac

- 230 Vac single phase geared motor with built-in control unit and encoder
- The encoder device ensures crush prevention and precision in the gate moving phases
- Control unit equipped with electronic braking
- Version equipped with magnetic limit switches available (BULL20M.S)

400 Vac

- 400 Vac three phase geared motor with external control unit and electronic braking
- Version equipped with magnetic limit switches available (BULL20T.S)

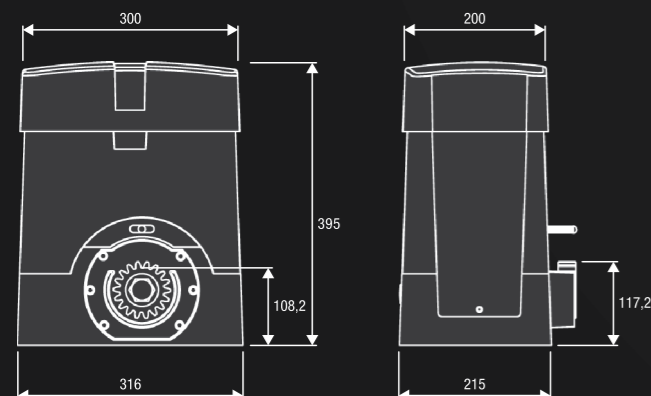

RI.M4F
9272010
M4 rack 30x12x1000mm slotted and galvanized. Supplied with M6 metric screws and threaded spacers.
Packaging: 4 pcs



RI.M4Z
9272030
M4 galvanized rack (22x22x2000 mm).
Packaging: 2 pcs



RI.M6Z
9272040
M6 galvanized rack 30x30x2000 mm. (needs the RI.P6 accessory to work).



RI.P6
9630001
M6 gear, It needs the rack RI.M6Z.



BULL.PI
9623005
Raised foundation plate. 280 x 170, n.4 Ø 11 floor brackets, 269 x 106 n.4 M10 screws for motor.



SB.BULL20.F
9747026
Externally fitted anti-intrusion cable unlock device (L=4.5m).



RF.SUN
9409015
Battery-operated device recharged by means of a photovoltaic panel applied on a mobile edge. (Technical features on p. 176)



RF
9409016
Device with a non rechargeable battery, with guaranteed duration 2 years. (Technical features on p. 176)



SC.RF
9409014
Device powered at 12/24 Vdc with self-test function and 2 outputs for connection to the electronic control panels. (Technical features on p. 176)



ID.TA
9846019
Warning board.



ESA BASIC
9176108
System that reduces the electrical energy consumption.

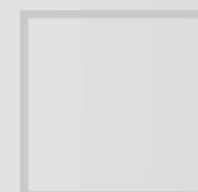
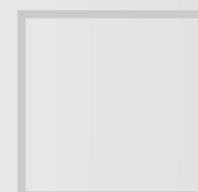
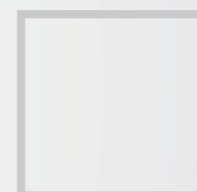
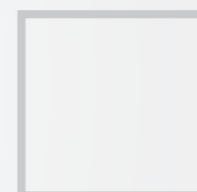
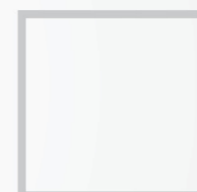
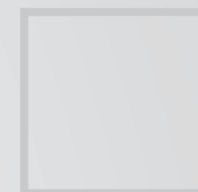

MADE IN ITALY

TECHNICAL DATA	BULL20M	BULL20M.S	BULL20T	BULL20T.S
Code	9590577	9591018	9590578	9591412
Power supply	230 Vac (50-60Hz)	230 Vac (50-60Hz)	≈ 400 Vac (50-60Hz)	≈ 400 Vac (50-60Hz)
Motor supply	230 Vac	230 Vac	≈ 400 Vac	≈ 400 Vac
Max absorbed current	2.9 A	2.9 A	1.7 A	1.7 A
Max Thrust	1667 N	1667 N	2000 N	2000 N
Opening speed	10.5 m/min	10.5 m/min	10.5 m/min	10.5 m/min
Operation cycle	40%	40%	intensive use	intensive use
Protection level	IP44	IP44	IP44	IP44
Built-in control unit	YES	YES	NO	NO
Magnetic limit switches	NO	YES	NO	YES
Operating temperature	-20°C /+50°C	-20°C /+50°C	-20°C /+50°C	-20°C /+50°C
Max gate weight	2000 kg	2000 kg	2000 kg	2000 kg
Driving gear for rack	M4 Z18	M4 Z18	M4 Z18	M4 Z18
Weight	21.6 kg	21.6 kg	21.6 kg	21.6 kg
Items no. per pallet	20	20	20	20